

# Residual Gas Analyzers

Residual

LEYSPEC

330.00.02

Excerpt from the Leybold Full Line Catalog (Edition 2022)

Catalog Part Residual Gas Analyzers

# Products

## Residual Gas Analyzers

### LEYSPEC view and LEYSPEC ultra



The LEYSPEC product family offers simple and intuitive operation with an on-board control and display unit. Simple residual gas analysis is possible without even connecting the device to a computer.

Due to the intuitive interface, the Residual Gas Analyzer (RGA) is very easy to operate. At the push of a button, you can display the partial pressures of key gases and if your process involves an additional gas, you can assign it to the spare display channel. Due to the high bake-out temperatures achievable, the RGA is ideal for use in demanding high vacuum and ultra high vacuum applications.

The LEYSPEC RGA offers greatest sensitivity combined with an intuitive software that allows all basic and advanced test procedures.

#### Advantages to the User

##### - Intuitive software

The intelligent and intuitive LEYSPEC software completes the offering. The easy user interface allows a wide range of use cases, from simple operations to complex analysis. Creating recipes is as easy as it should be: Quick and convenient. During operation the total pressure is displayed and different views can be chosen to fit the view for the purpose of the analysis. Choose between the scan mode, trend mode or analog mode

##### - Highest Sensitivity

The LEYSPEC product family offers the highest sensitivity for the most accurate residual gas analysis. This allows detecting even the smallest traces of contaminants or process gases

##### - Highest bake-out

With its high bake out temperatures of up to 300°C, the LEYSPEC ultra is perfectly suited for sophisticated high and ultra high vacuum applications. The LEYSPEC ultra range offers highest bakeout temperature so even in harsh environments reliable gas analysis can be performed

##### - Advanced feature

Preinstalled software functions allow many additional functionalities and test procedures such as a helium leak test or setting of warnings and error levels for selectable gases. A programmable degas function is implemented for simple process degassing after start or exposure to atmosphere. The background suppression allows focussing on the important peaks

##### - Different product types

The new LEYSPEC range offers the perfect solution for any application in mass spectrometry. Focusing on residual gas analysis the product range offers solutions for 100, 200 or 300 amu – depending on the process requirements. All products come with the integrated display for easy and quick operations as well as the LEYSPEC software for sophisticated test procedures and residual gas analysis. Compact in size and mountable in any orientation, the LEYSPEC product range is perfectly suited for different built-in situations

#### Typical Applications

##### LEYSPEC view

- Residual gas analysis in high vacuum pumping equipment
- Gas analysis in R&D, freeze drying, analytical systems and many more
- Analysis of organic materials
- Environmental tracking
- Gas impurity analysis

##### LEYSPEC ultra

- Advanced range for all residual gas analysis
- For sophisticated residual gas analysis with higher sensitivity
- Reliable detection of very low partial pressures
- Suited for higher bake-out temperatures

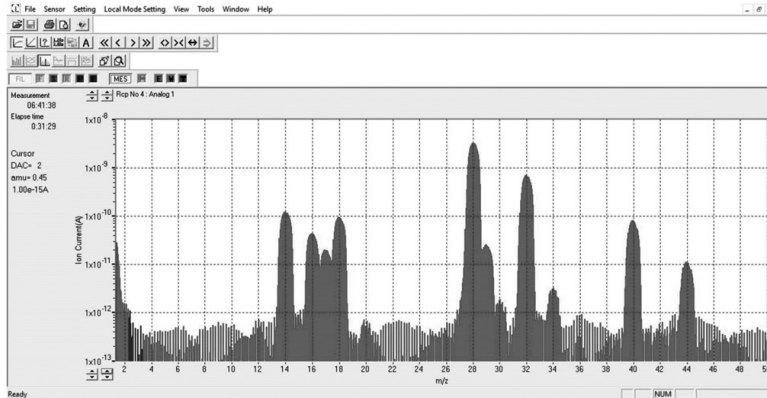

Analog mode

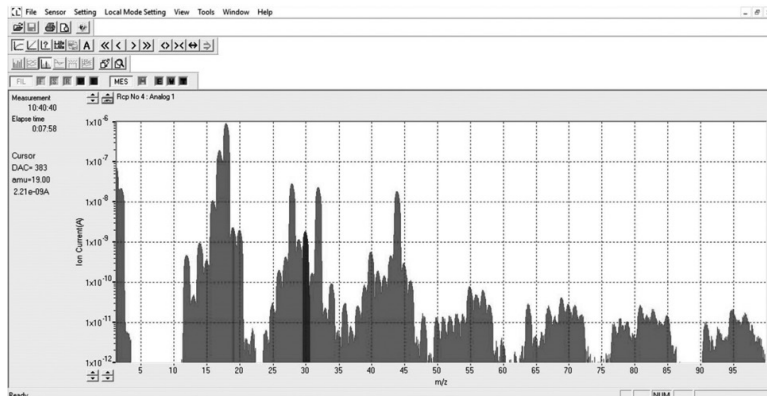

Analog mode hydrocarbons

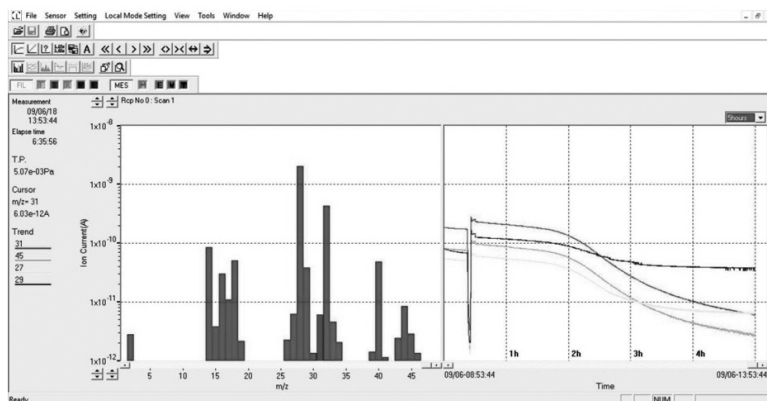

Scan and trend mode

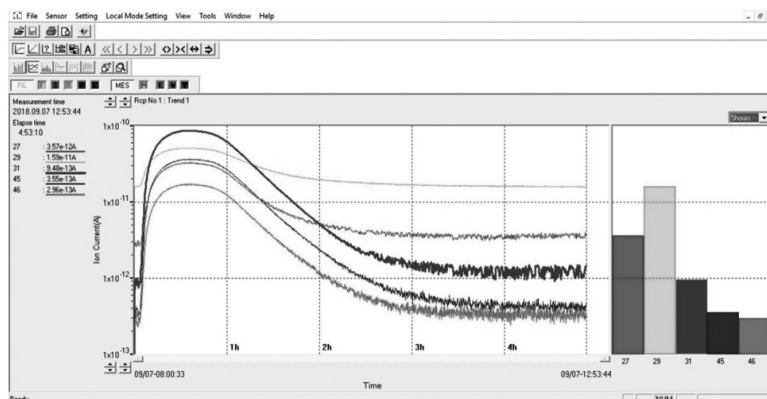

Trend mode

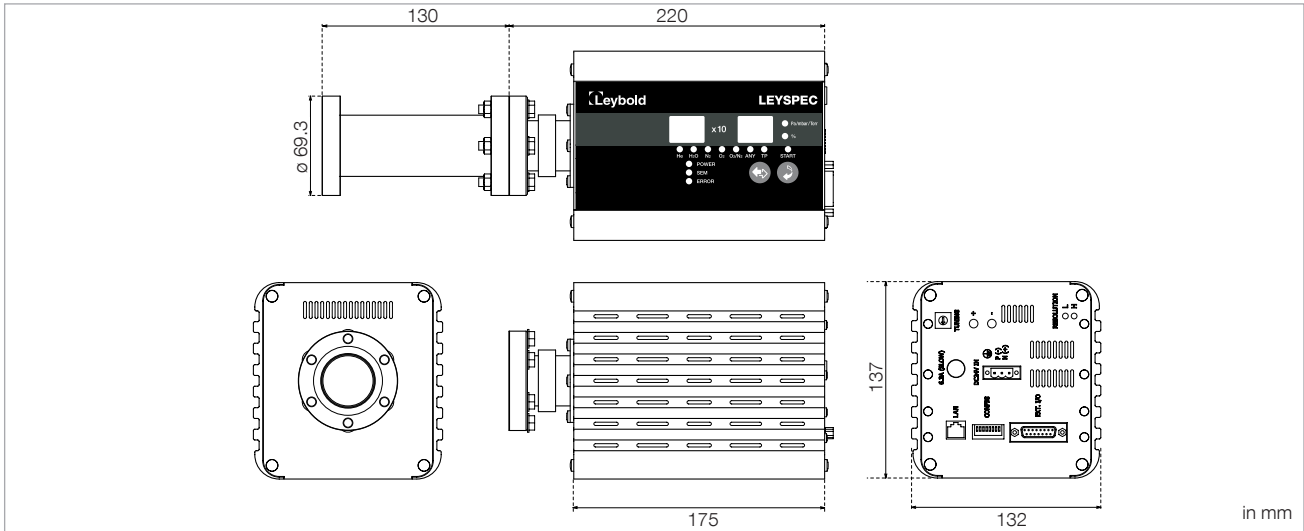

Dimensional drawing for LEYSPEC view 100 / 200

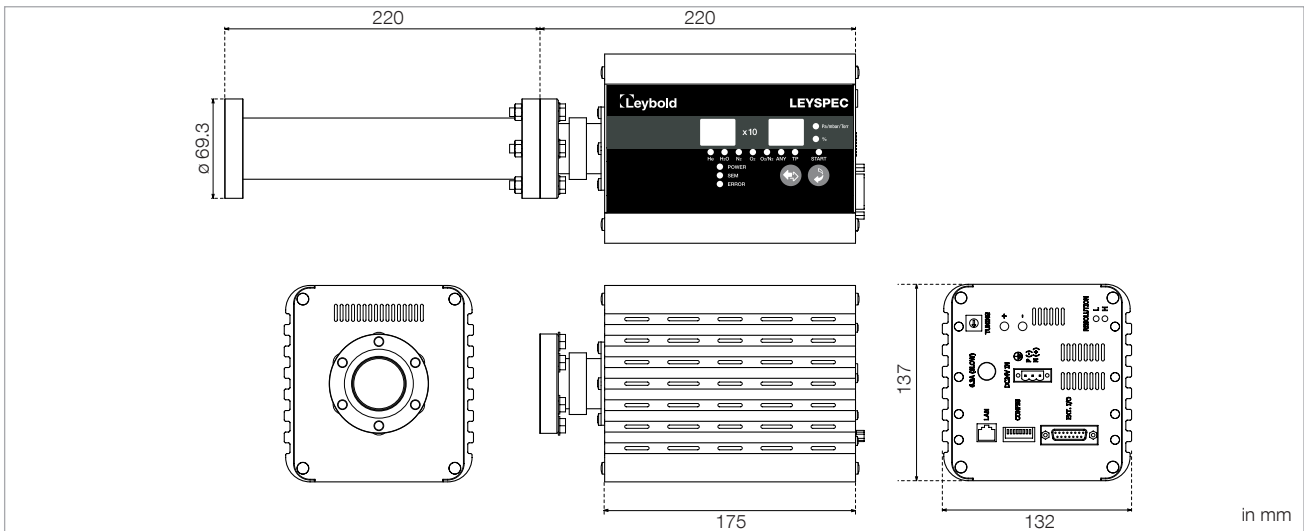

Dimensional drawing for LEYSPEC view 100S / 200S

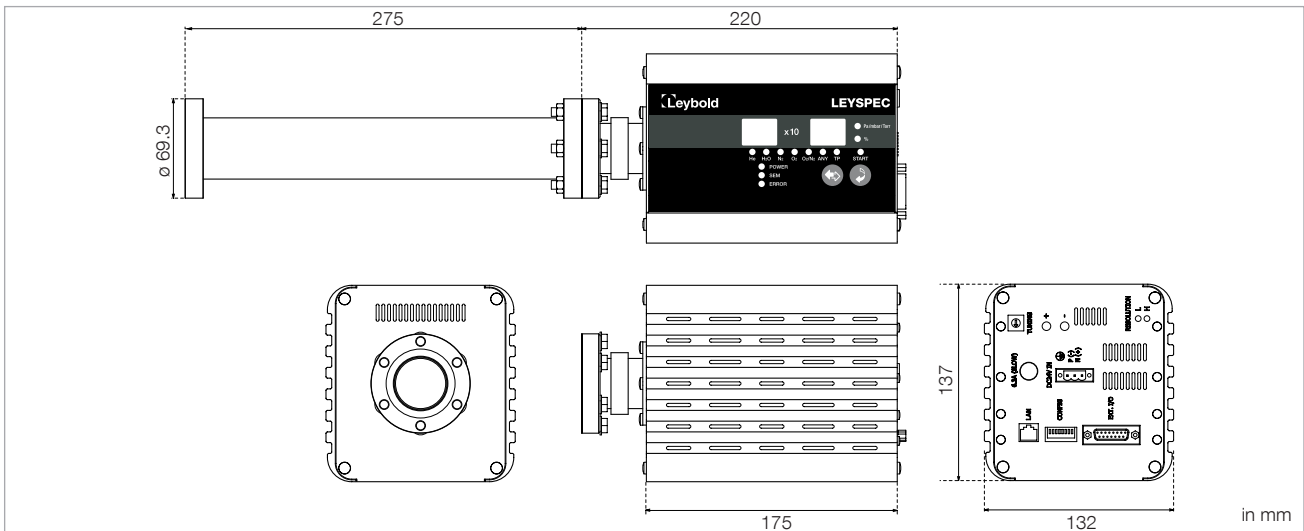

Dimensional drawing for LEYSPEC ultra 200S / 300S

## Technical Data

## LEYSPEC

[view 100](#) [view 100S](#) [view 200](#) [view 200S](#) [ultra 200S](#) [ultra 300S](#)

Mass range	amu	1 - 100	1 - 100	1 - 200	1 - 200	1 - 200	1 - 300
Mass filter type		QMS					
Detector type		Faraday cup	EM / Faraday cup	Faraday cup	EM / Faraday cup	EM / Faraday cup	EM / Faraday cup
Sensitivity	A / mbar	1 x 10 <sup>-5</sup>	400/1 x 10 <sup>-5</sup>	1 x 10 <sup>-5</sup>	400/1 x 10 <sup>-5</sup>	400/2.5 x 10 <sup>-4</sup>	400/2.5 x 10 <sup>-4</sup>
Minimum detectable partial pressure	mbar	1 x 10 <sup>-10</sup>	1 x 10 <sup>-14</sup> / 1 x 10 <sup>-10</sup>	1 x 10 <sup>-10</sup>	1 x 10 <sup>-14</sup> / 1 x 10 <sup>-10</sup>	1 x 10 <sup>-15</sup> / 1 x 10 <sup>-11</sup>	1 x 10 <sup>-15</sup> / 1 x 10 <sup>-11</sup>
Maximum operating pressure	mbar	1 x 10 <sup>-4</sup>					
Filament material		Ir/Y203					
Operating temperatur	°C	10 - 40					
Maximum sensing temperature	°C	120	120	120	120	250	250
Maximum bake out temperature (electronics removed)	°C	250	250	250	250	300	300
Connection flange		DN 40 CF					
Power input		DC 24 V ± 10% 50 W					
Weight	kg	2.6	2.8	2.6	2.8	3.2	3.2
IP		30					
Serial communication		RS232C / RS485					
Software		LEYSPEC software					
Resolution		M / DeltaM = 1M(10%PH)					

## Ordering Information

## LEYSPEC

[view 100](#) [view 100S](#) [view 200](#) [view 200S](#) [ultra 200S](#) [ultra 300S](#)

	Part No.	Part No.	Part No.	Part No.	Part No.	Part No.
LEYSPEC	220010V01	220011V01	220012V01	220013V01	220020V01	220021V01





# Sales and Service

## Germany

**Leybold GmbH**  
Bonner Strasse 498  
D-50968 Cologne  
T: +49-(0)221-347 1234  
F: +49-(0)221-347 31234  
sales@leybold.com  
www.leybold.com

**Leybold GmbH  
Sales Area North**  
Branch Office Berlin  
Industriestrasse 10b  
D-12099 Berlin  
T: +49-(0)30-435 609 0  
F: +49-(0)30-435 609 10  
sales.bn@leybold.com

**Leybold GmbH  
Sales Office South**  
Branch Office Munich  
Karl-Hammerschmidt-Strasse 34  
D-85609 Aschheim-Dornach  
T: +49-(0)89-357 33 9-10  
F: +49-(0)89-357 33 9-33  
sales.mn@leybold.com  
service.mn@leybold.com

**Leybold Dresden GmbH  
Service Competence Center**  
Zur Wetterwarte 50, Haus 304  
D-01109 Dresden  
Service:  
T: +49-(0)351-88 55 00  
F: +49-(0)351-88 55 041  
info.dr@leybold.com

## Europe

### Belgium

**Leybold Nederland B.V.  
Belgisch bijkantoor**  
Leuvensesteenweg 542  
B-1930 Zaventem  
Sales:  
T: +32-2-711 00 83  
F: +32-2-720 83 38  
sales.zv@leybold.com  
Service:  
T: +32-2-711 00 82  
F: +32-2-720 83 38  
service.zv@leybold.com

### France

**Leybold France S.A.S.**  
Parc du Technopolis, Bâtiment Beta  
3, Avenue du Canada  
F-91940 Les Ulis cedex  
Sales and Service:  
T: +33-1-69 82 48 00  
F: +33-1-69 07 57 38  
sales.or@leybold.com  
orsay.sav@leybold.com

**Leybold France S.A.S.**  
Valence Factory  
640, Rue A. Bergès  
B.P. 107  
F-26501 Bourg-lès-Valence Cedex  
T: +33-4-75 82 33 00  
F: +33-4-75 82 92 69  
marketing.vc@leybold.com

## Great Britain

**Leybold UK LTD.**  
Unit 9  
Silverglade Business Park  
Leatherhead Road  
Chessington  
Surrey (London)  
KT9 2QL  
Sales:  
T: +44-13-7273 7300  
F: +44-13-7273 7301  
sales.ln@leybold.com  
Service:  
T: +44-13-7273 7320  
F: +44-13-7273 7303  
service.ln@leybold.com

## Italy

**Leybold Italia S.r.l.**  
Via Filippo Brunelleschi 2  
I-20093 Cologno Monzese  
Sales:  
T: +39-02-27 22 31  
F: +39-02-27 20 96 41  
sales.mi@leybold.com  
Service:  
T: +39-02-27 22 31  
F: +39-02-27 22 32 17  
service.mi@leybold.com

## Netherlands

**Leybold Nederland B.V.**  
Floridadreef 102  
NL-3565 AM Utrecht  
Sales and Service:  
T: +31-(30) 242 63 30  
F: +31-(30) 242 63 31  
sales.ut@leybold.com  
service.ut@leybold.com

## Russia

**Leybold Russia**  
Vashutinskoe Road 15,  
Khimki, Moscow region,  
141402  
Russia  
T: +7 495 933 55 50  
LeyboldRussia@leybold.com

## Switzerland

**Leybold Schweiz AG**  
Hinterbergstrasse 56  
CH-6312 Steinhausen  
Warehouse and shipping address:  
Riedthofstrasse 214  
CH-8105 Regensdorf  
Sales:  
T: +41-44-308 40 50  
F: +41-44-308 40 60  
sales.zh@leybold.com  
Service:  
T: +41-44-308 40 62  
F: +41-44-308 40 60  
service.zh@leybold.com

## Spain

**Leybold Hispánica, S.A.**  
C/. Huelva, 7  
E-08940 Cornellá de Llobregat  
(Barcelona)  
Sales:  
T: +34-93-666 43 11  
F: +34-93-666 43 70  
sales.ba@leybold.com  
Service:  
T: +34-93-666 46 11  
F: +34-93-685 43 70  
service.ba@leybold.com

## Leybold GmbH

Bonner Strasse 498  
D-50968 Cologne  
T: +49-(0)221-347-0  
F: +49-(0)221-347-1250  
info@leybold.com

## America

### USA

**Leybold USA Inc.**  
6005 Enterprise Drive  
Export, PA 15632  
USA  
Sales and Service:  
T: +1-800-764-5369  
F: +1-800-325-4353  
F: +1-800-215-7782  
sales.ex@leybold.com  
service.ex@leybold.com

### Brazil

**Leybold do Brasil Ltda.**  
Av. Tamboré, 937, Tamboré  
Distrito Industrial  
CEP 06460-000 Barueri - SP  
Sales und Service:  
T: +55 11 3376 4604  
info.ju@leybold.com

## Asia

### P. R. China

**Leybold (Tianjin)  
International Trade Co. Ltd.**  
Beichen Economic  
Development Area (BEDA),  
No. 8 Western Shuangchen Road  
Tianjin 300400  
China  
Sales and Service:  
T: +86-400 038 8989  
T: +86-800 818 0033  
F: +86-22-2697 4061  
F: +86-22-2697 2017  
sales.tj@leybold.com  
service.tj@leybold.com

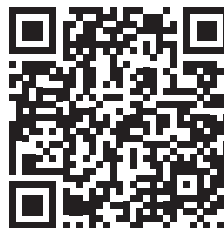

### India

**Leybold India Pvt Ltd.**  
T-97/2, MIDC Bhosari  
Pune-411 026  
Indien  
Sales and Service:  
T: +91-80-2783 9925  
F: +91-80-2783 9926  
sales.bgl@leybold.com  
service.bgl@leybold.com

### Japan

**Leybold Japan Co., Ltd.**  
Shin-Yokohama A.K.Bldg., 4th floor  
3-23-3, Shin-Yokohama  
Kohoku-ku, Yokohama-shi  
Kanagawa-ken 222-0033  
Japan  
Sales:  
T: +81-45-471-3330  
F: +81-45-471-3323  
sales.yh@leybold.com

## Malaysia

**Leybold Malaysia  
Leybold Singapore Pte Ltd.**  
No. 1 Jalan Hi-Tech 2/6  
Kulim Hi-Tech Park  
Kulim, Kedah Darul  
Aman 09090  
Malaysia  
Sales and Service:  
T: +604 4020 222  
F: +604 4020 221  
sales.ku@leybold.com  
service.ku@leybold.com

## South Korea

**Leybold Korea Ltd.**  
25, Hwangsaeul-ro 258 beon-gil,  
undang-gu, Seongnam-si,  
Gyeonggi-do,  
(7F Sunae Finance Tower)  
13595 Bundang  
Sales:  
T: +82-31 785 1367  
F: +82-31 785 1359  
sales.bd@leybold.com  
Service:  
T: +82-41 589 3035  
F: +82-41 588 0166  
service.cn@leybold.com

## Singapore

**Leybold Singapore Pte Ltd.**  
42 Loyang Drive  
Loyang Industrial Estate  
Singapore 508962  
Singapore  
Sales and Service:  
T: +65-6303 7030  
F: +65-6773 0039  
info.sg@leybold.com

## Taiwan

**Leybold Taiwan Ltd.**  
10F., No. 32, Chenggong 12th St.,  
Zhubei City, Hsinchu County 302  
Taiwan, R.O.C.  
Sales and Service:  
T: +886-3-500 1688  
F: +886-3-550 6523  
info.hc@leybold.com

**Leybold**

www.leybold.com